

# TCD 2013

For mobile machinery

74.9 - 243 kW | 100 - 325.9 hp at 2100 - 2300 min<sup>-1</sup> | rpm

EU Stage IIIA / US EPA Tier 3

- Water-cooled 4 and 6-cylinder inline engines with turbocharging and charge air cooling
- The powerful DEUTZ Common-Rail (DCR<sup>®</sup>) injection system and the electronic engine control (EMR 3) with intelligent link to the drive management ensure optimum engine performance at low fuel consumption.
- The 4-cylinder is also available with a mechanical injection system.
- Best cold starting properties even under extreme conditions.

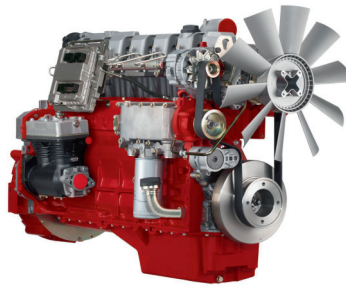

- Low noise emissions due to acoustically optimized components with very smooth running and high durability.

- The compact engine design and three PTO drive possibilities integrated into the gear drive reduce the installation costs and increase the number of applications.
- Wet cylinder liners, long oil change intervals and easy changing of the engine fluids reduce the running and service costs and increase the availability of the machinery.
- The robust engine design allows worldwide operation even with high sulphur fuels.

## Technical data

Engine type		TCD 2013 L4 2V <sup>5)</sup>	TCD 2013 L4 2V	TCD 2013 L6 2V	TCD 2013 L6 4V
No. of cylinders		4	4	6	6
Bore/stroke	mm   in	108/130   4.3/5.1	108/130   4.3/5.1	108/130   4.3/5.1	108/130   4.3/5.1
Capacity	l   cu in	4.8   292.9	4.8   292.9	7.2   439.4	7.2   439.4
Compression ratio		18.1:1	18.1:1	18.1:1	18.1:1
Nominal speeds	min <sup>-1</sup>   rpm	2100-2300	2000-2300	1800-2300	2200
<b>Power output<sup>1)</sup></b>					
Power output as per ISO 14396	kW   hp	104   140	129   173	200   268	243   325.9
at speed	min <sup>-1</sup>   rpm	2200	2300	2300	2100
Max. torque	Nm   lb/ft	565   416.7	670   494.2	1050 <sup>4)</sup>   774.4	1310   966.2
at speed	min <sup>-1</sup>   rpm	1600	1600	1500	1450
Minimum idling speed	min <sup>-1</sup>   rpm	900	650	650	800
Specific fuel consumption <sup>2)</sup>	g/kWh   lb/hph	218   0.358	208   0.342	205   0.337	204   0.335
Weight as per DIN 70020 Part 7A <sup>3)</sup>	kg   lb	500   1102	500   1102	610   1345	660   1455

1) Capacity data without deduction of fan capacity

2) Best full load consumption refers to diesel with a density of 0.835 kg/dm<sup>3</sup> at 15°C | 6.96 lb/US gallon at 60°F.

3) Without starter/dynamo, cooler and fluids but with flywheel and flywheel housing.

4) 1100 Nm | 811.3 lb-ft with switched internal EGR (exhaust gas return).

5) Mechanical injection system

The data on this data sheet are for information purposes only and are not binding values. The data in the quotation is definitive.

## Torque curve

TCD 2013 L4 2V - 129 kW|173 hp  
TCD 2013 L4 2V - 104 kW|140 hp

TCD 2013 L6 2V - 200 kW|268 hp

TCD 2013 L6 4V - 243 kW|325.9 hp  
(2100 min<sup>-1</sup>|rpm)

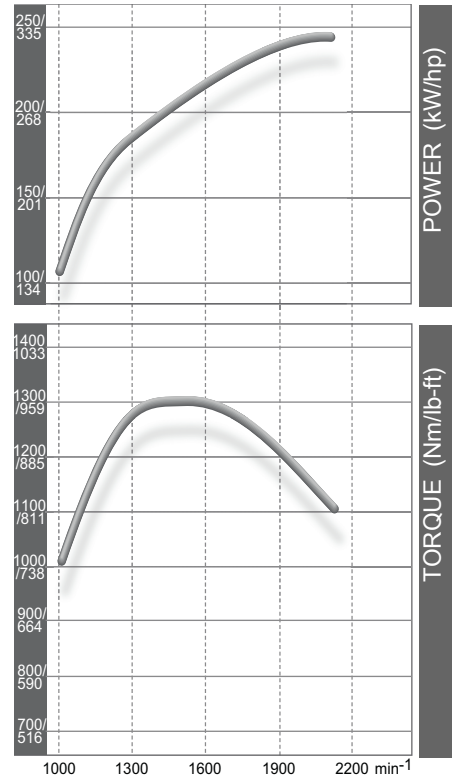
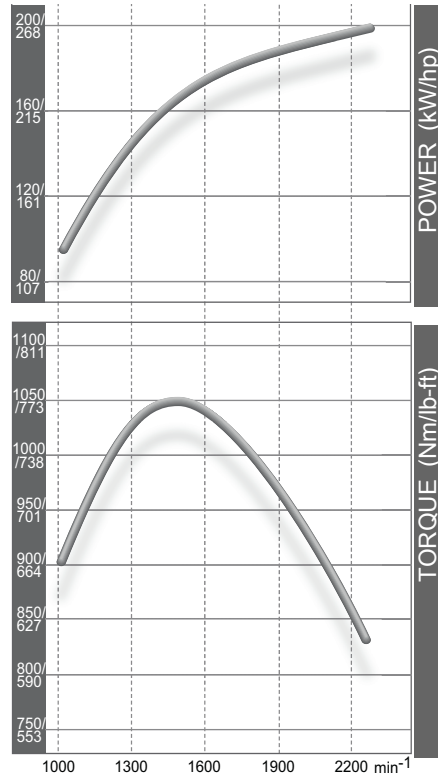
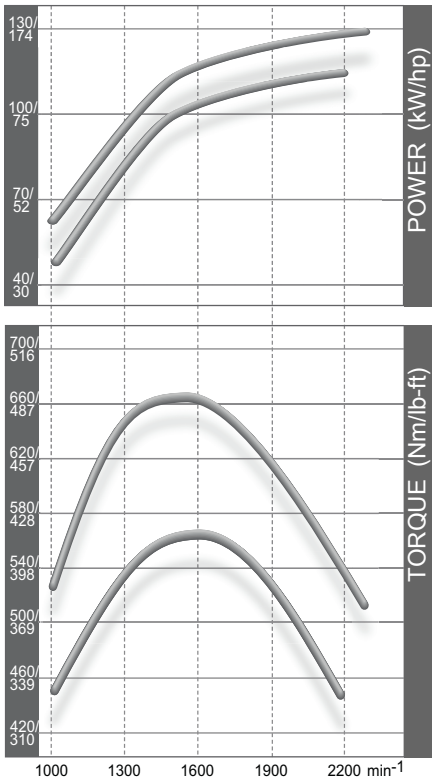

## Dimensions

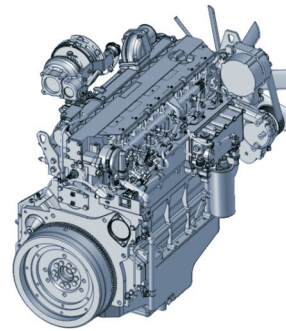
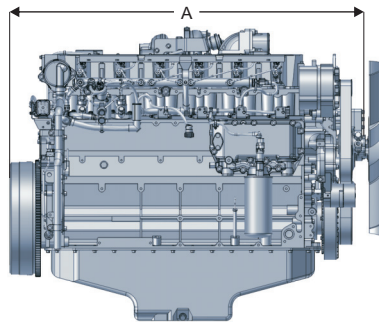
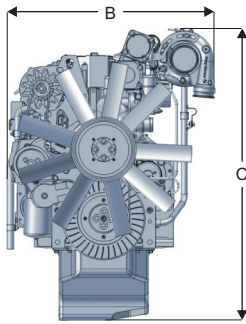

		A	B	C
TCD 2013 L4 2V	mm   in	857   33.7*	638   25.1	870   34.2
TCD 2013 L6 2V	mm   in	1154   45.4**	694   27.3	991   39.0
TCD 2013 L6 4V	mm   in	1158   45.6**	703   27.7	974   38.3

\* V-belt drive

\*\* Poly-V belt drive

Note: The engine dimensions and weights vary depending on the scope of delivery.

For more information please contact the DEUTZ AG Köln or the responsible sales partner.

